

Measuring across R17 (/HSYNC, SER_PULSE)

OUT: 74HCT377

2019-02-11

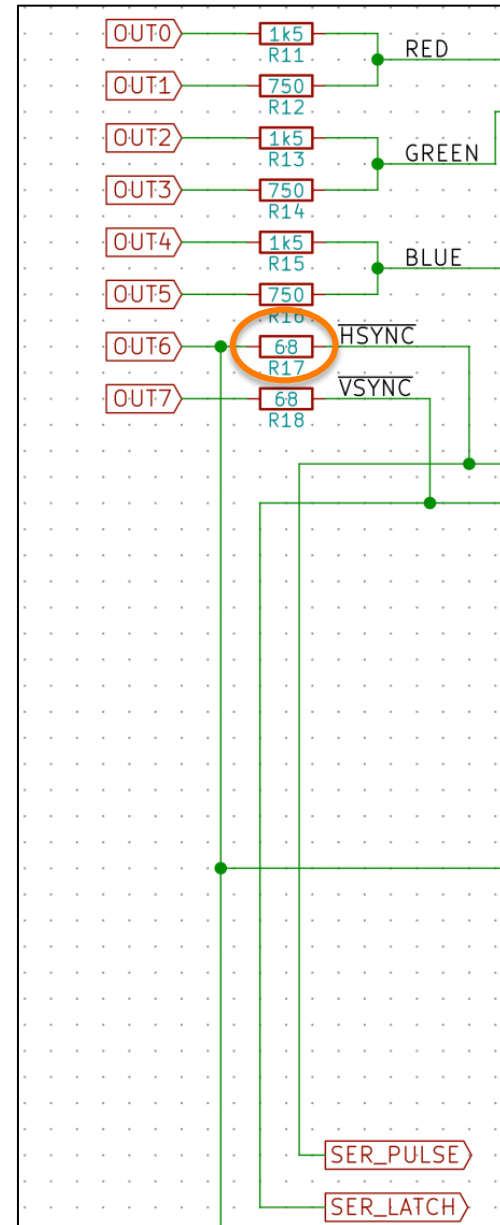

Measurement setup

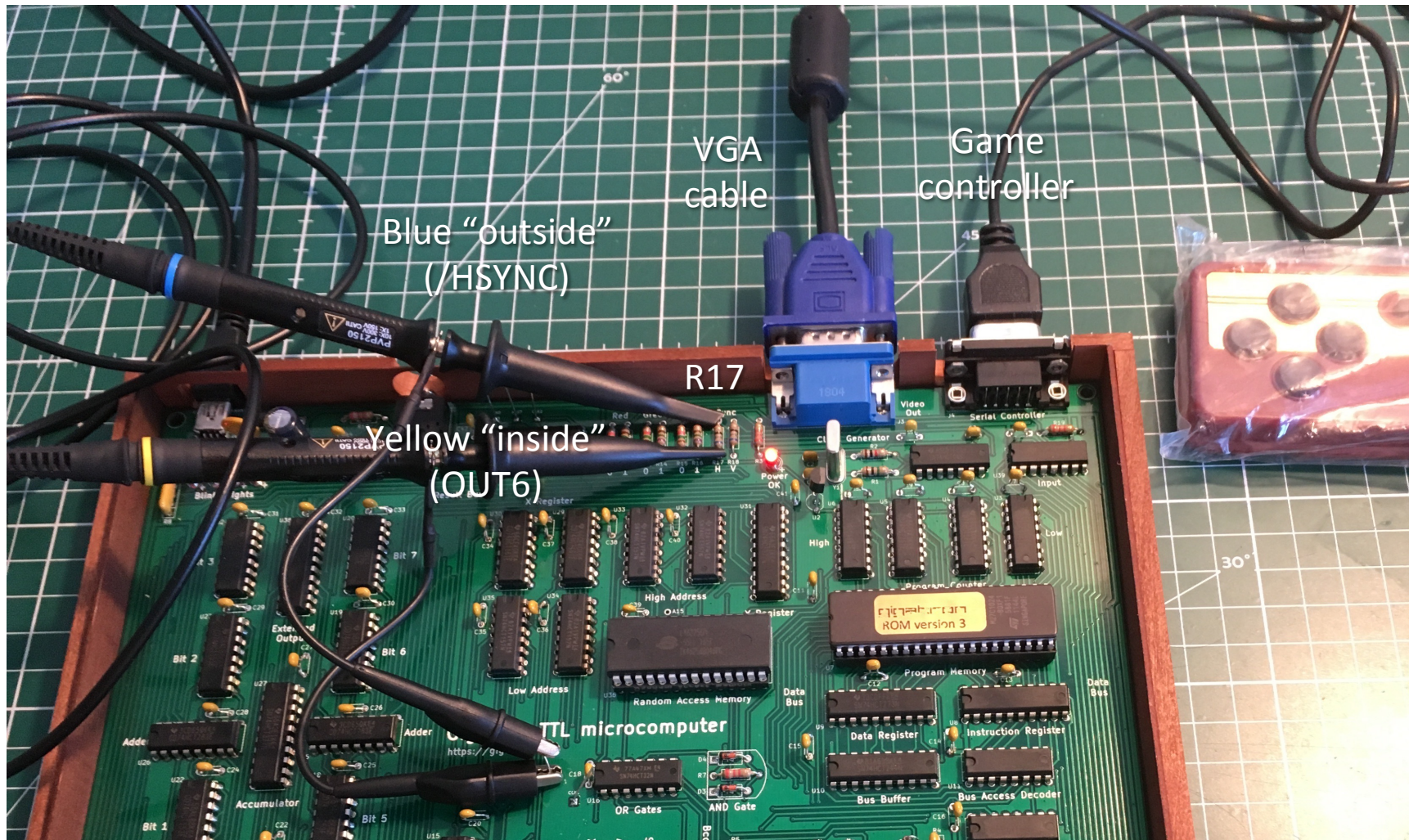

Bypassing: $R17=0\Omega$

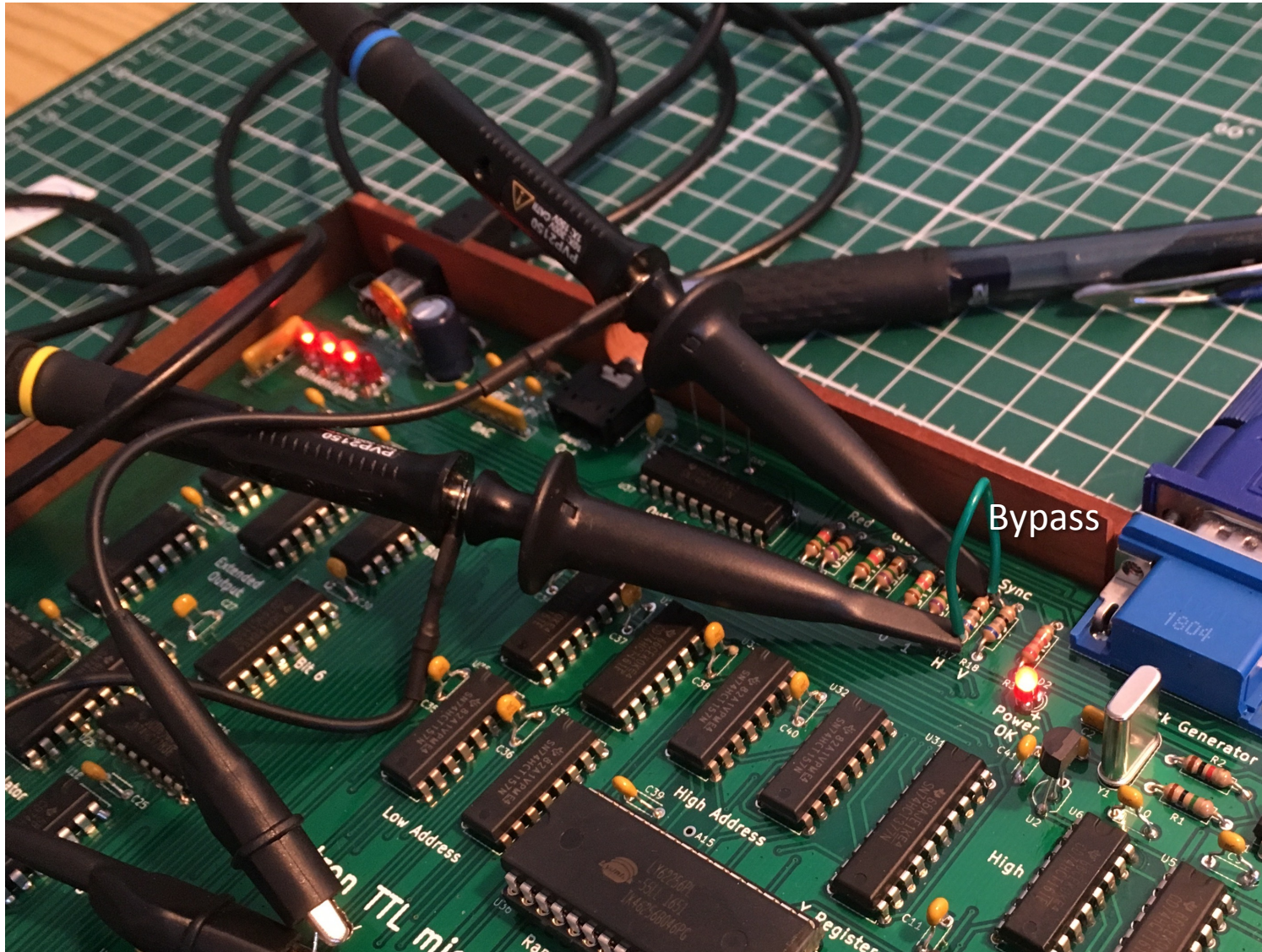

Both VGA and game controller connected

R17=68Ω

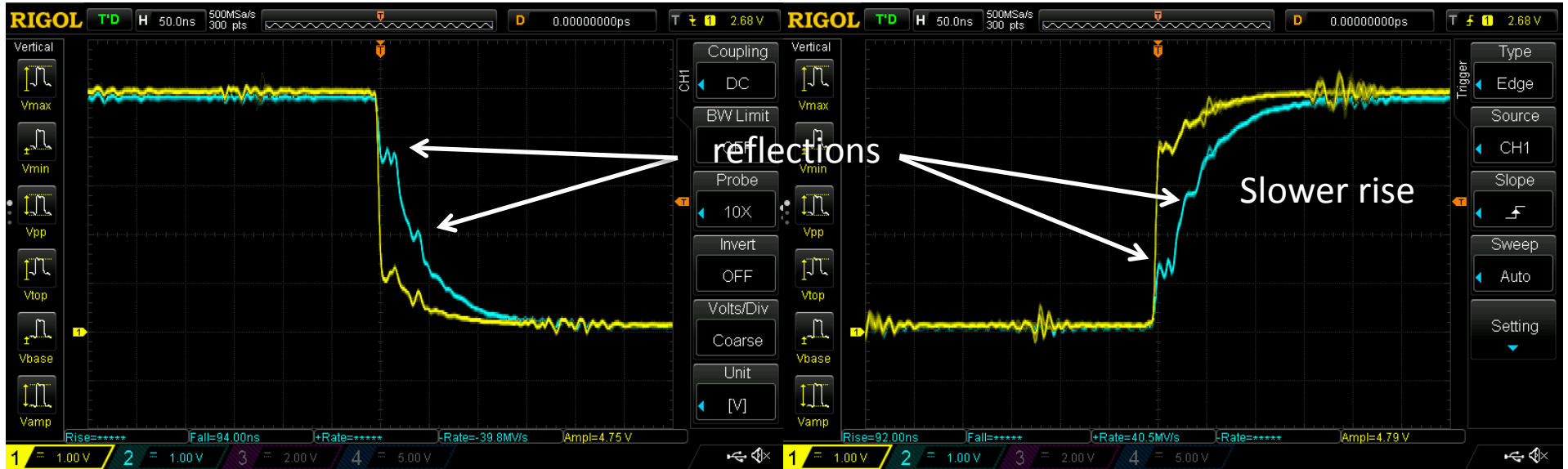

R17=0Ω

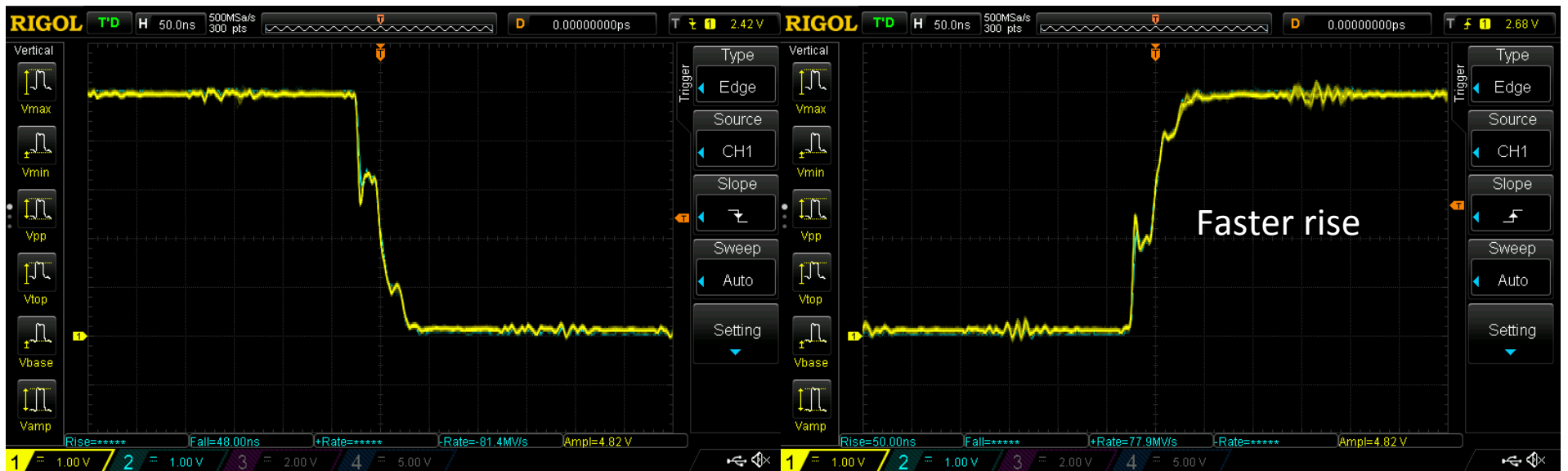

Only VGA connected

R17=68Ω

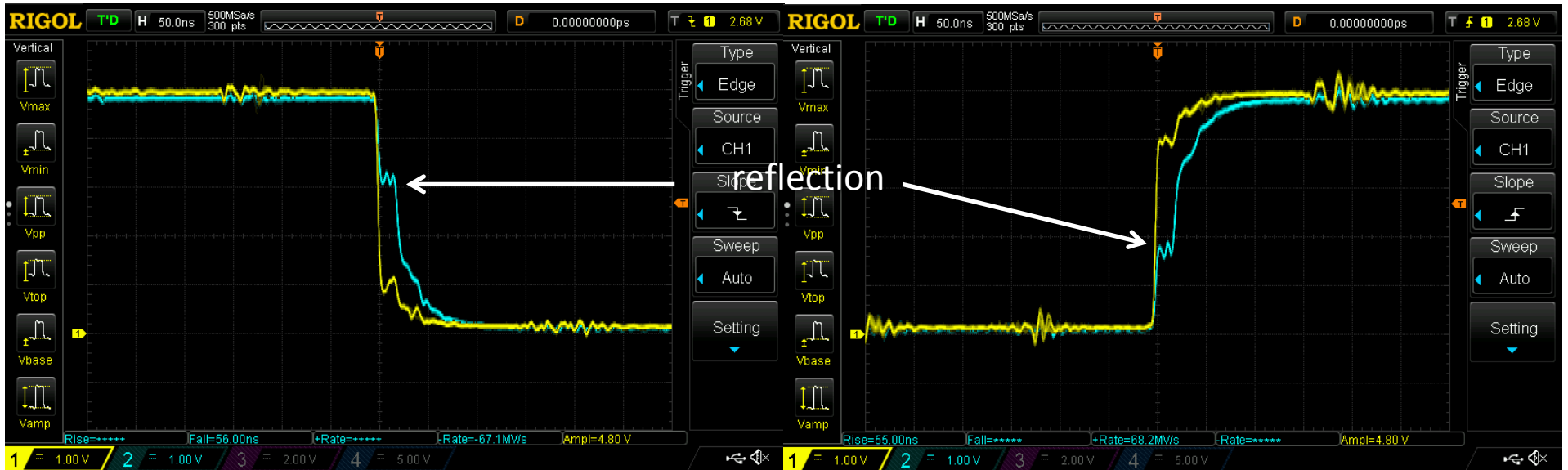

R17=0Ω

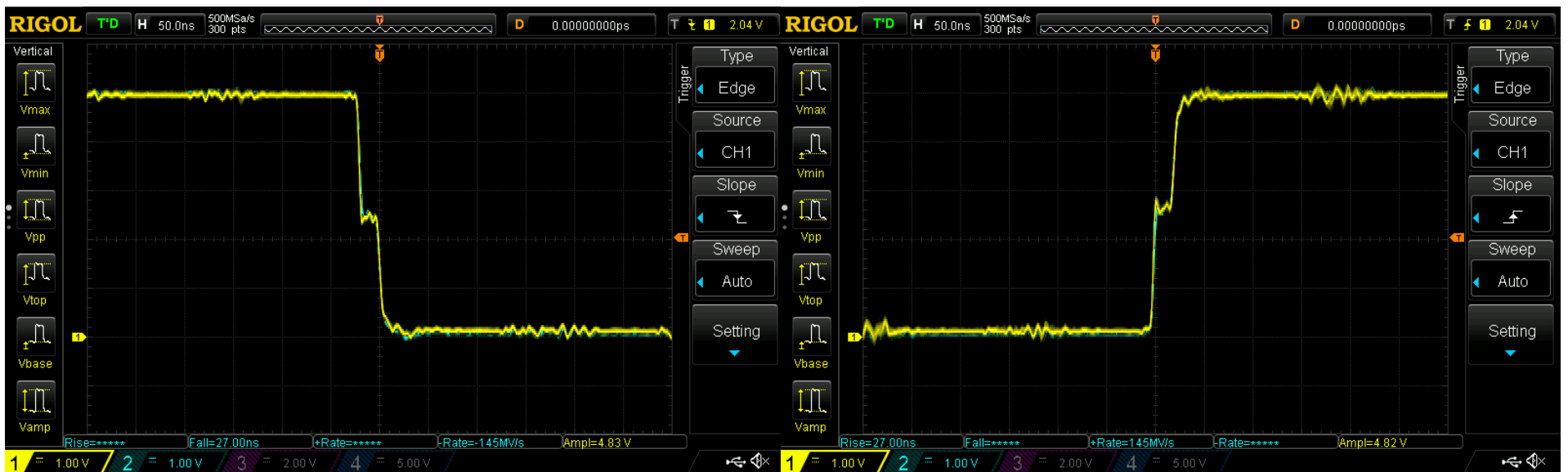

Nothing connected

R17=68Ω

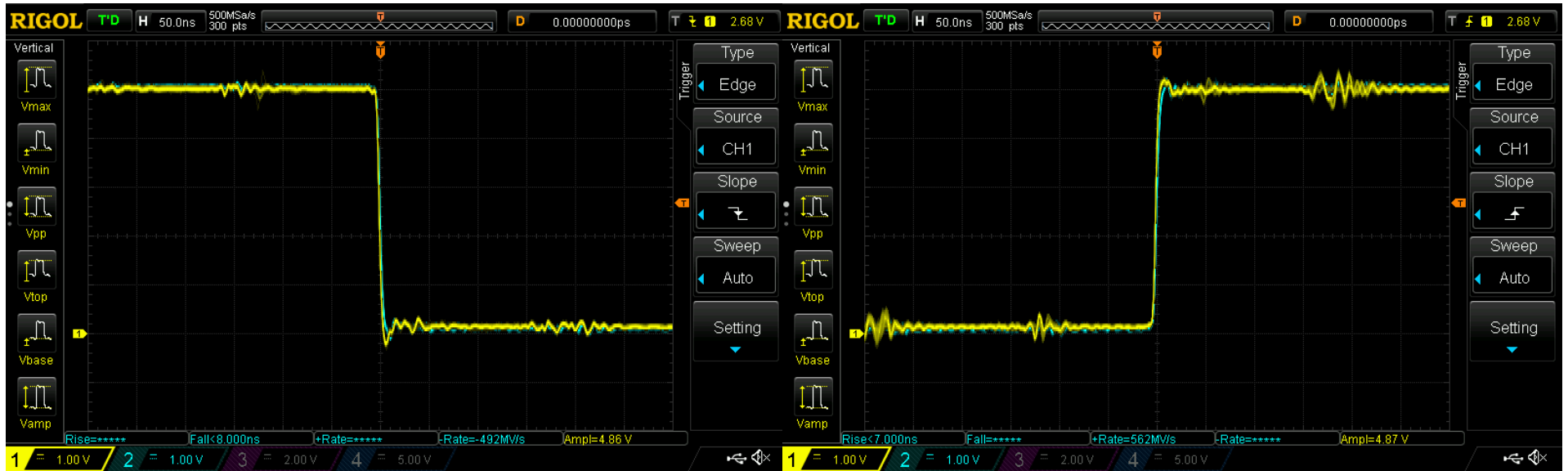

R17=0Ω

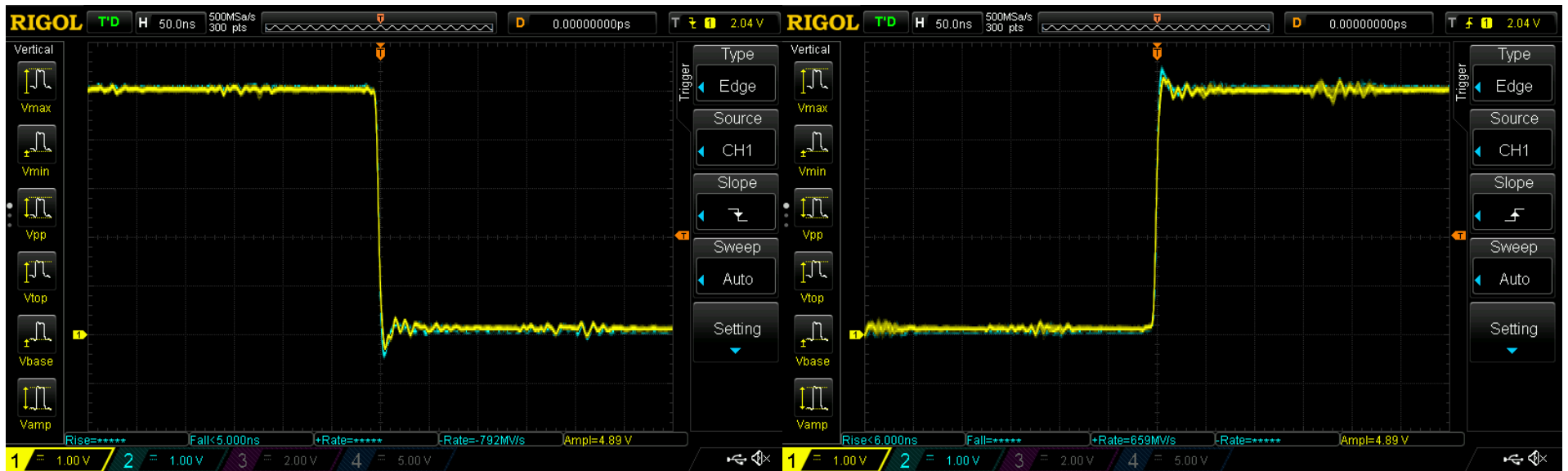

Only game controller connected

R17=68Ω

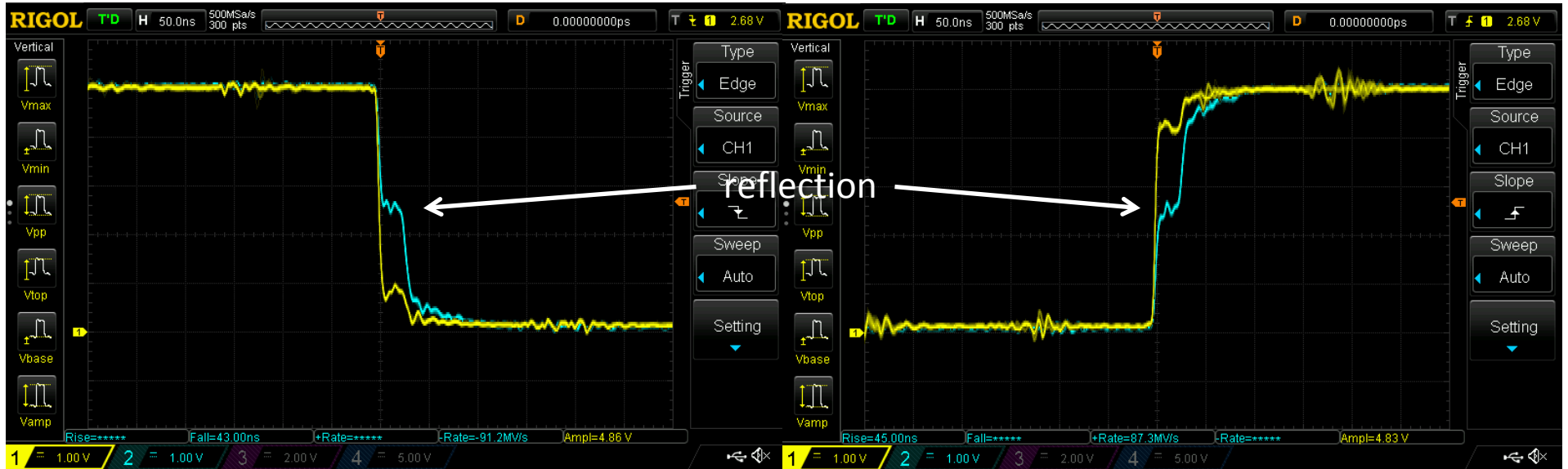

R17=0Ω

